

Climate Sensor & Data Logger with LCD Display

Specifications

Power	24Vdc, ~5W
Max Cable Distance	1000ft
Aspirator	6cfm Fan with Foam Filter
Temperature Range	-20 - 60°C
Temperature Accuracy	±0.2°C typical ±0.4°C maximum
Humidity Range	0-100% RH (non condensing) 80% RH Max Operating
Humidity Accuracy	±2% 0-80% typical ±4% maximum
Light Irradiance Range	0 - 1000W/m2
Light Accuracy	±10%
CO2 Range	0-40,000ppm
CO2 Accuracy	±50ppm + 3% of reading
4-20mA DAC Resolution	12 bit, 0.005mA
Protocols Supported	GrowNET or MODBUS



Contents

Features	2
Warnings & Notices	3
Installation Instructions	4
Cable Connector Seal Boot	4
Maintenance & Service	5
Cleaning	5
Fan Filter	5
Fan Replacement	6
CO2 ppm Sensor Upgrade	7
LCD Menu Operation	8
High / Low History	8
Graphing	8
Main Menu	9
Alarms Menu	9
Alarms Configuration	9
Alarm Buzzer	10
Calibration Menu	10
Temperature or Humidity Calibration	10
CO2 Calibration	11
Clear Calibration	11
Advanced Calibration	12

Analog Output Calibration	12
Setup Menu	13
Time / Date	13
Units	13
Logging Interval	14
COMM Mode	14
Device Address	15
Manufacturing Info	15
Display Back Light Timer	15
Connection to GrowControl™ GCX	16
GrowNET™ Hubs	16
Connection to RX4i Intelligent Relay	17
Cross-Over Cable	17
Connection to USB AgrowLINK	18
Connection to 4-20mA Outputs	18
Connection to MODBUS RTU	19
Serial Speed & Format	19
Supported Commands	20
Register Types	20
Sensor Value Registers	20
Toggle Units Register	20
Calibration Registers	20
MODBUS Holding Registers	21
Storage and Disposal	22
Warranty	22

KEEP THESE INSTRUCTIONS

REV 5/23

Features

GrowControl™ SXE is a precision digital indoor sensor featuring temperature, humidity, and ambient light sensors standard. Optional CO2 ppm sensor allows accurate readings up to 40,000 ppm with reliable NDIR sensor technology. Fan aspirated for continuous accuracy with removable air filter.

Intended for wall mounting near eye level using the mounting flanges and holes provided on the enclosure. Ideal for drying rooms and other environments where an integrated display can provide immediate feedback and monitoring of the sensor readings. Display indicates current readings in large, clear text and has high/low reporting, graphical history, visual/audible alarm indication and more.

Internal memory logs over 20,000 data points per sensor. Connects to Agrowtek's GrowControl™ Cultivation Controllers as part of a complete facility control solution.

LX1 USB AgrowLink connects the GrowNET™ port to a PC with free PC software for datalog download, graphing, calibration, configuration, firmware updates, etc. LX2 ModLINK connects GrowNET™ devices to RS-422/485 for MODBUS RTU protocol communication.

A CR2032 battery may be installed to maintain the internal clock for stand-alone data logging applications. *(A battery is not required for standard operation.)*

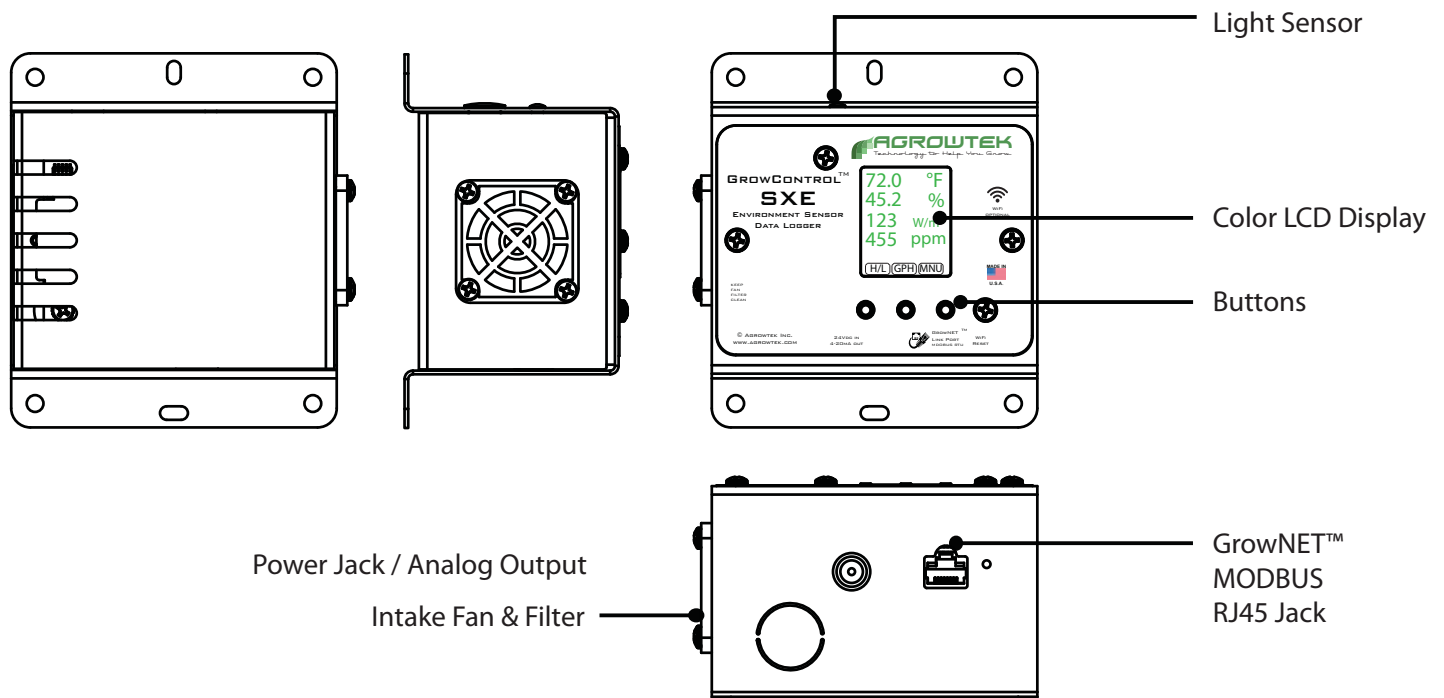

Note: Power jack is typically not used (power is provided by RJ-45 GrowNET port.)

⚠ Do not drill additional holes into the enclosure.

Warnings & Notices

SXC Environment sensors are precision electronic instruments which require attention and care to maintain their accuracy and reliability. Failure to operate the sensors properly can cause damage and equipment failure.

⚠ Always bag or remove sensors when spraying chemicals or fogging.

⚠ Do not spray the sensor with water or chemicals. Protect sensor from direct water exposure.

⚠ Do not locate the sensor near HVAC vents, humidifiers, or dehumidifiers, lighting equipment, etc.

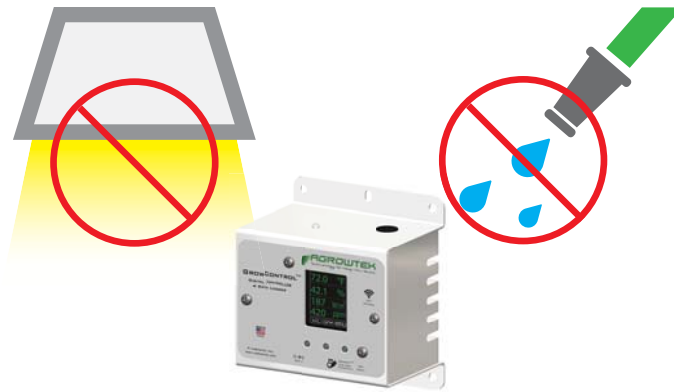

⚠ NOTICE

GrowNET™ ports use standard RJ-45 connections but are NOT compatible the Ethernet network equipment. *Do not connect GrowNET™ ports to Ethernet ports or network switch gear or equipment damage may result.*

⚠ DIELECTRIC GREASE

Dielectric grease is recommended on RJ-45 GrowNET™ connections when used in humid environments. Place a small amount of grease onto the RJ-45 plug contacts before inserting into the GrowNET™ port.

- Loctite LB 8423
- Dupont Molykote 4/5
- CRC 05105 Di-Electric Grease
- Super Lube 91016 Silicone Dielectric Grease
- Other Silicone or Lithium based insulating grease

Installation Instructions

Installation Location Requirements:

- Air must adequately circulate to the sensor and be representative of the environment.
- Away from undue influence such as ventilation ducts, doorways/windows, lights or hot equipment
- In a dry location away from mists, sprays and rain.
- At operator level and away from dead corners and spaces.

Mounting flanges are provided with holes to secure the sensor unit to a wall.

Note the location of the light sensor (top.) Sensor must be installed with the light sensor facing up and the fan facing down.

Do not install with RJ-45 port facing "up."

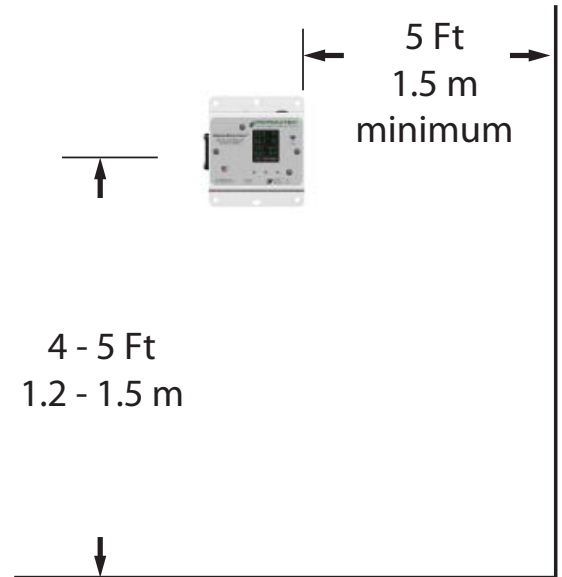

Cable Connector Seal Boot

A sealing boot kit is included with new sensors and should be installed to prevent damage to the cable connector or PCB jacks in the event of accidental exposure to sprays or mists.

1. Install the DC power jack cover by pressing the black port cover into the hole until it snaps into place.
2. Install the gray plastic adapter ring into the RJ-45 connector hole.
3. Slide the CAT5 cable through the boot. Use a damp cloth to lubricate the cable jacket if necessary.
4. Crimp and test the RJ-45 cable connector.
5. Plug the RJ-45 connector into the jack.
6. Stretch the boot and seat it around the port adapter.

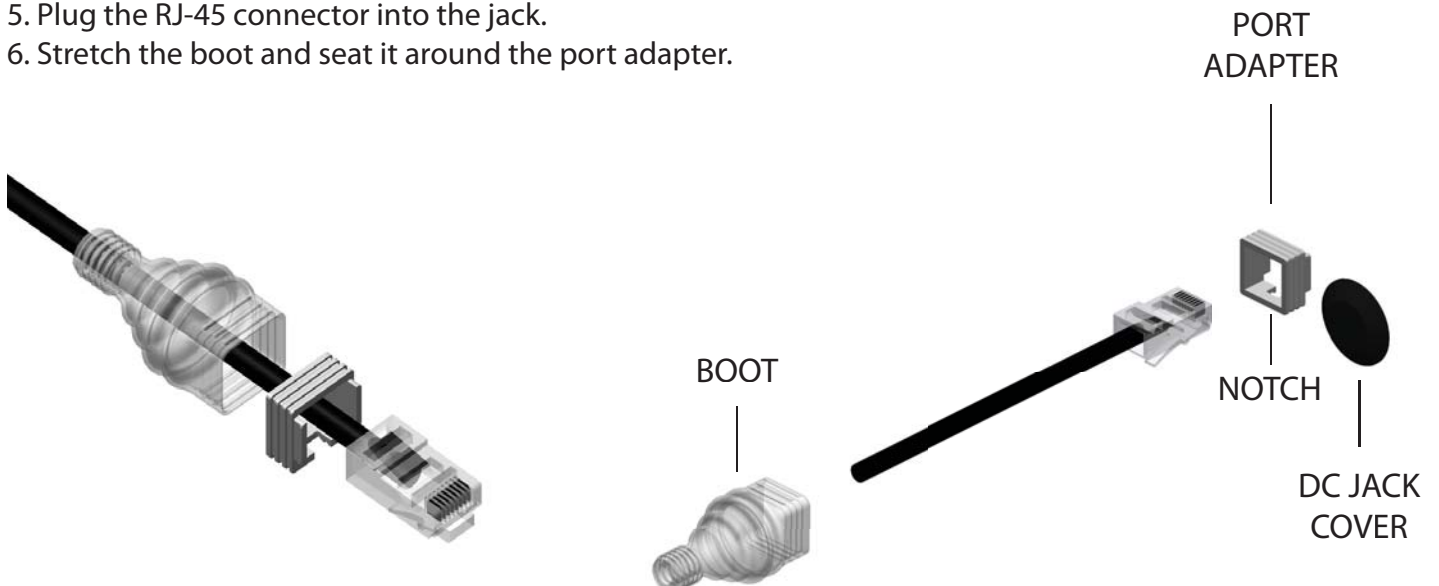

Maintenance & Service

Sensors require periodic maintenance to ensure proper performance.

Cleaning

Exterior and label surfaces may be wiped with a damp cloth with mild dish detergent, then wiped dry. Avoid spraying the sensor with chemicals or water spray.

Fan Filter

The fan air filter should be periodically removed for cleaning.

It is NOT necessary to remove the fan.

1. Pry the retaining grate (1) out of the base (3) using a small flat blade eye-glass screwdriver.
2. Remove the foam filter (2) and replace, or clean with mild dish detergent and water, then pat dry.
3. Check for proper fan operation while the filter is removed.
If fan is not spinning or is making noise, replace the fan.
4. Re-install the foam filter (2) and grate (1) into the base (3) gently snapping the grate back into place.

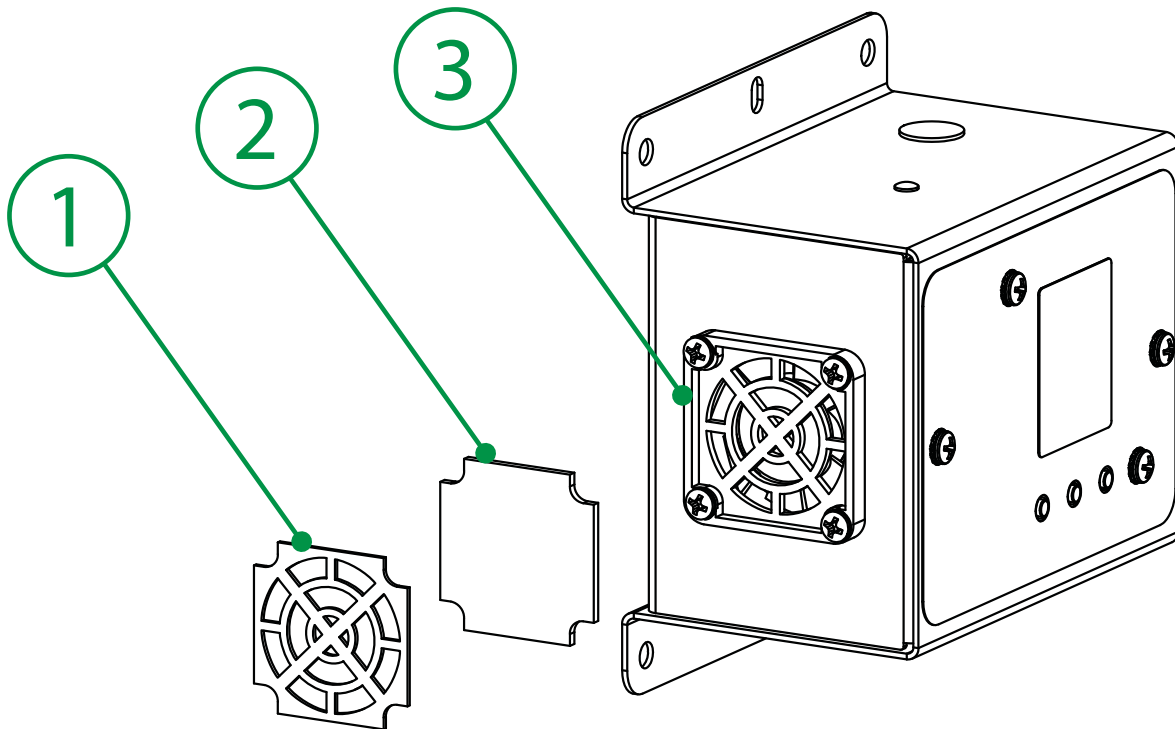

Fan Replacement

The fan may require replacement in the event of failure.

1. Disconnect power from the sensor and un-mount from the wall.
2. Remove the rear cover by removing the two screws (1).
3. Remove the four screws (2) and nuts (3) securing the fan and filter assembly to the housing.
4. Disconnect the fan wires from the terminal block and install the new fan leads to match.
5. Clean and re-install the fan filter on the outside, and the new fan on the inside of the rear cover.
6. Hand tighten the four fan screws and re-install the rear cover using the two cover screws.

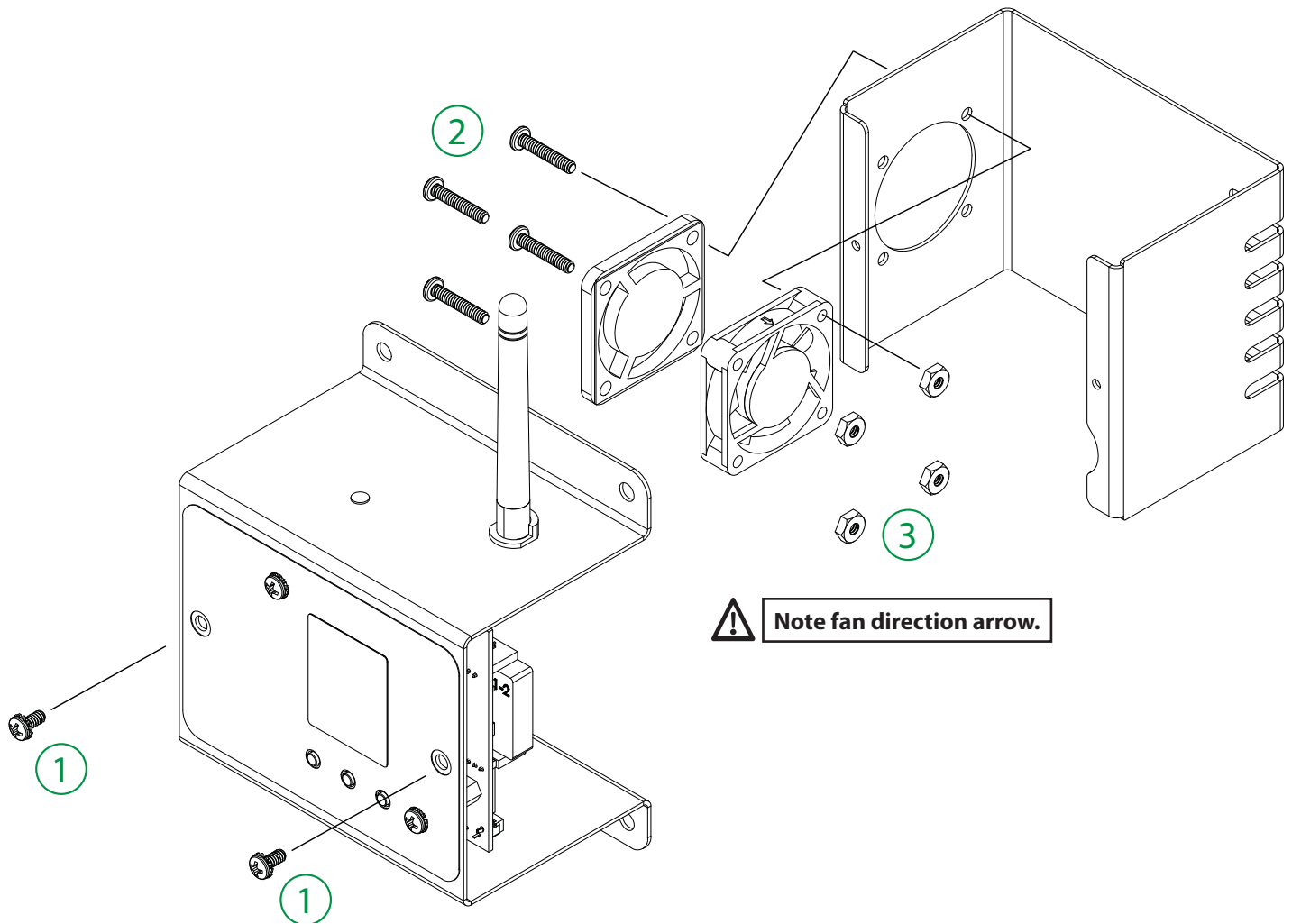

CO2 ppm Sensor Upgrade

The SXE sensor may be upgrade to sense and control CO2 ppm with a precision NDIR type CO2 sensor.

1. Disconnect power from the sensor.
2. Remove the rear cover by removing the two screws; use caution not to damage the fan wires.
3. Locate the CO2 headers.
4. Position and install the CO2 sensor module ensuring the sensor is oriented with the correct pin headers.
5. Re-install the rear cover and re-connect power. Check to ensure the CO2 reading is now working.

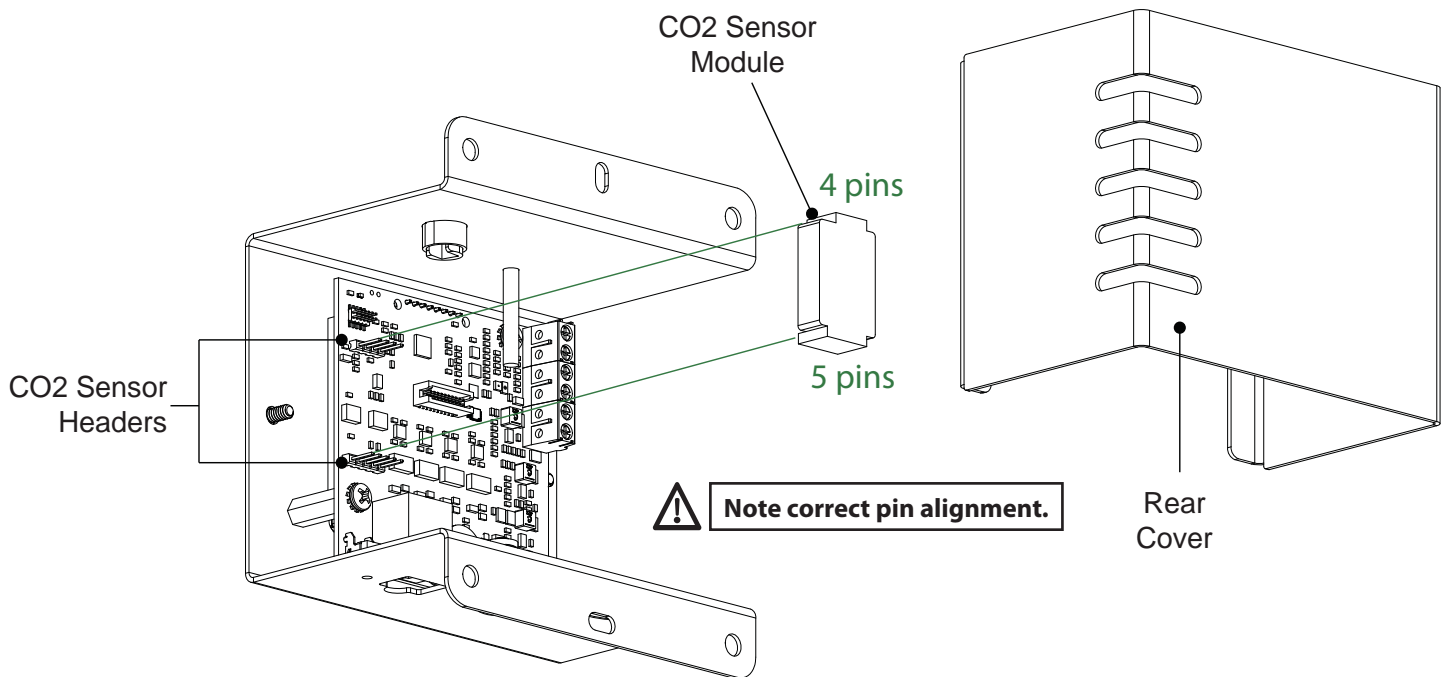

LCD Menu Operation

The main screen displays the real-time sensor readings from the attached sensors.

Three buttons are located beneath the screen. Each button is labeled at the bottom of the display to describe its function in the current screen or menu.

The main screen displays the real-time sensor readings from the attached sensors. Each button is labeled at the bottom of the display to describe its function on the current screen or menu.



High / Low History

H/L

Simple minimum and maximum recorded values are stored until the user resets the values to the current readings. To view the minimum and maximum values since the last reset, press the button labeled **H/L**.

To clear the min/max history, press the **RST** button to reset. The min and max values will all be set to the current readings and will update with higher or lower readings as they occur.

LOW	HIGH	
68.4	72.0	°F
23.1	45.2	%
0	123	W/m ²
455	1255	ppm

EXIT **RST**

Graphing

GPH

The display can graph the most recent 120 data points from the sensor's internal data point memory. With the default logging interval of 60 seconds, the graph displays the last two hours of data.

The sensor value is plotted in green. Temperature, if overlaid on the plot, is red. Alarm levels as set by the user are plotted in yellow. Pressing the **RFH** button refreshes the data and replots the graph.

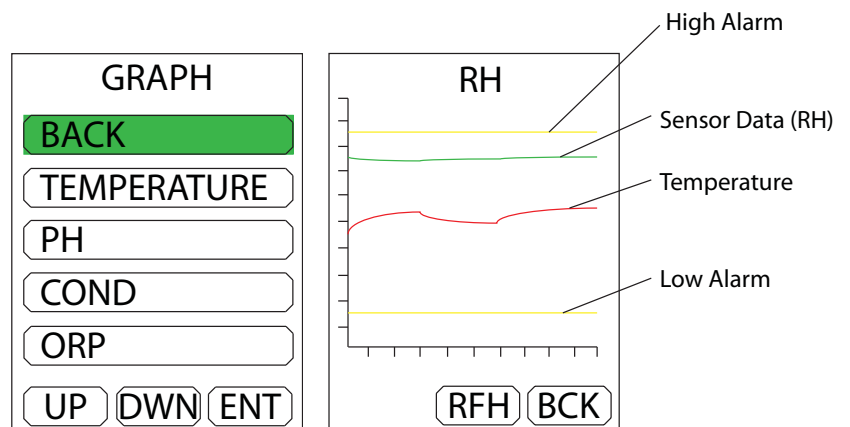

Main Menu

MNU

The main menu is how the alarms are set, sensors are calibrated and general settings such as time, date and units are configured.

If a dosing pump is directly connected to the SXHM GrowNET port, the pump settings are also accessed by the main menu.

Use the **UP** or **DWN** buttons to navigate the menu.

Use the **ENT** button to enter a selection.

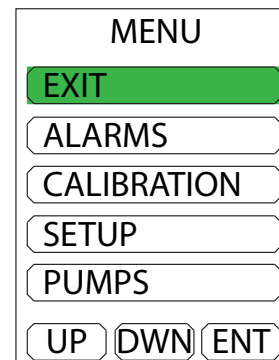

Alarms Menu

MNU ► ALARMS

High and low alarm set points may be configured for each sensor value to activate an internal buzzer or send alerts with the optional wifi module.

The out-of-range value will be displayed in **red** to indicate the cause for the alarm.

Additionally, alarm limits are plotted on the graphs to indicate values are within the desired range.

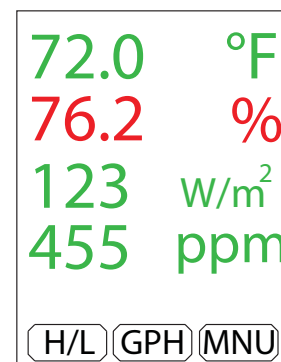

Alarms Configuration

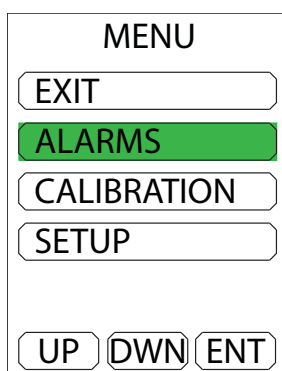

1. Select **ALARMS** from the main menu.

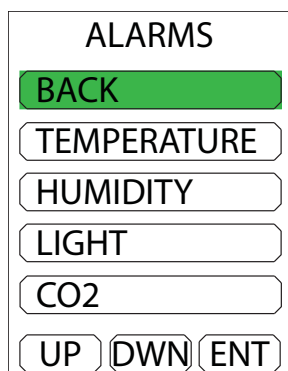

2. Select a sensor to configure set points.

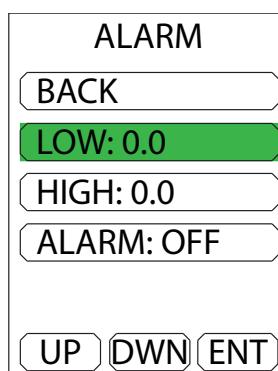

3. Select the setting to adjust.

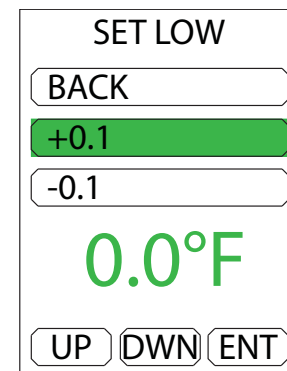

4. Adjust to the desired value. Hold **UP** or **DWN** to jog the value.

Alarm Buzzer

ALARM

BACK

LOW: 0.0

HIGH: 0.0

ALARM: OFF

UP DWN ENT

1. Select **ALARM: OFF**

SET ALARM

BACK

SET ON

SET OFF

OFF

UP DWN ENT

2. Select **SET ON** then press **BACK** to exit.

To disable the alarm buzzer, set the alarm to OFF.

Calibration Menu

MNU ► CALIBRATION

Calibration can be performed for each sensor with the LCD interface using either standard calibration wizards, or advanced manual calibration methods for non-standard calibration solutions.

The date of the last calibration for each sensor is stored in memory and displayed at the start of each calibration wizard.

MENU

EXIT

ALARMS

CALIBRATION

SETUP

UP DWN ENT

CALIBRATION

BACK

TEMPERATURE

HUMIDITY

CO2

CLEAR ALL

UP DWN ENT

Temperature or Humidity Calibration

MNU ► CALIBRATION ► TEMPERATURE

CALIBRATION

BACK

CALIBRATE

ADVANCED

UP DWN ENT

1. Select **CALIBRATE** from the temperature calibration menu.

TEMPERATURE
LAST CALIBRATION
10/19/2017

PRESS NEXT TO
ADJUST
TEMPERATURE
READING.

EXIT NEXT

2. Press **NEXT** to continue.

OFFSET

BACK

+0.1

-0.1

72.2°F

UP DWN ENT

3. Adjust to the desired value. Hold **ENT** to jog the value by 10x.

CONFIRM?

OLD
68.1 °F

NEW
72.2 °F

YES NO

4. Confirm the new reading or press **NO** to cancel.

CO2 Calibration

MNU ► CALIBRATION ► TEMPERATURE

CALIBRATION

BACK

CALIBRATE

ADVANCED

UP DWN ENT

1. Select **CALIBRATE** from the temperature calibration menu.

CO2

LAST CALIBRATION
10/19/2017

PUT SENSOR IN
OUTDOOR AIR.

EXIT NEXT

2. Press **NEXT** to continue.

CO2

389 ppm

WAIT FOR READING
TO STABILIZE THEN
PRESS DONE.

EXIT DNE

3. Wait 5-10 minutes and allow reading to normalize. Then press done to complete the calibration.

 **Keep away from the sensor during normalization (step 3) and press the done button upon approaching the sensor to avoid disturbing the calibration. Do not breathe near the sensor or locate near individuals, vehicles or other sources of carbon dioxide during calibration.**

Clear Calibration

MNU ► CALIBRATION ► NEXT

Calibration can be restored to factory defaults by selecting **CLEAR ALL**.

CALIBRATION

BACK

TEMPERATURE

PH

COND

CLEAR ALL

UP DWN ENT

1. Select **CLEAR ALL** from the calibration menu.

RESTORE TO
FACTORY
CALIBRATION?

YES NO

2. Press **YES** to restore factory calibration.

Advanced Calibration

Sensors values may be manually calibrated and if equipped, 4-20mA analog outputs may also be calibrated with a positive or negative offset to compensate for variation in DAC's/ADC's.

CO2

OFFSET calibration applies a linear offset adjustment to the value and can provide calibration to another meter as an alternative to calibrating in outdoor air. Adjust the value as required and confirm the new reading.

CALIBRATION

BACK

CALIBRATE

ADVANCED

UP DWN ENT

Analog Output Calibration

4-20mA analog outputs may also be calibrated with a positive or negative offset to compensate for variation in DAC's/ADC's. The sensors' current output may be incrementally increased or decreased in steps of 0.005mA over a range of +/-2mA.

1 Offset bit = 0.005mA, Range = +/-400 bits (+/-2mA)

This calibration procedure is optional and only for use with custom PLC applications.

1. Observe the PLC's input or data readings.
2. Increase or decrease the offset value to incrementally adjust the current output until the values match.

ANALOG

BACK

+1

-1

-5

UP DWN ENT

Setup Menu

MNU ► SETUP

The setup menu is where the time and date are set, the units are configured, logging interval is adjusted and advanced communications settings are available.

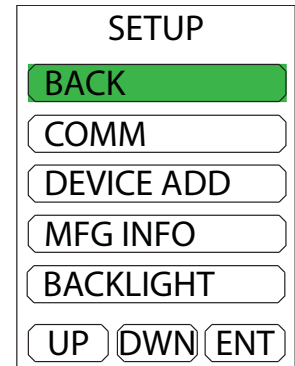
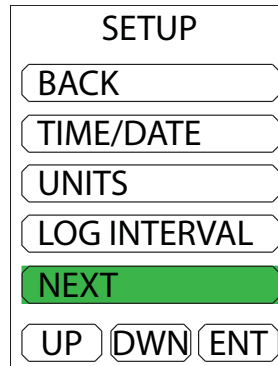

Time / Date

MNU ► SETUP ► TIME/DATE

Sensors include a precision real-time clock with battery back-up for time-stamping the data log information with the time and date. The last calibration for each sensor is also time stamped.

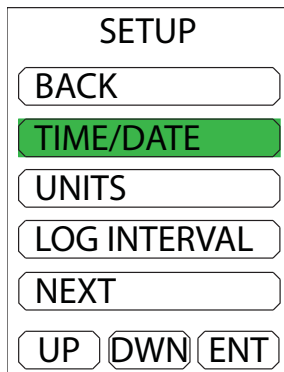

1. Select **TIME/DATE** from the setup menu.

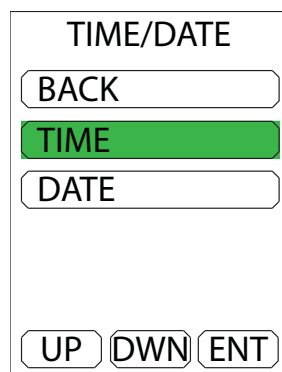

2. Select **TIME** or **DATE** to adjust.

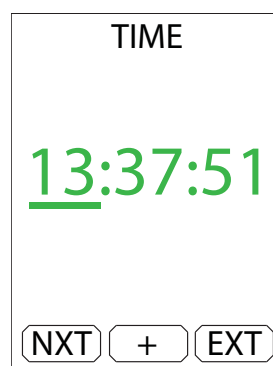

3. Use **NXT** to select the value to adjust. Use **+** to increment the value.



4. Use **EXT** to exit the menu.

Units

MNU ► SETUP ► UNITS

Temperature and Conductivity may be displayed in alternate units.

Select a sensor value to change the default display and working units.

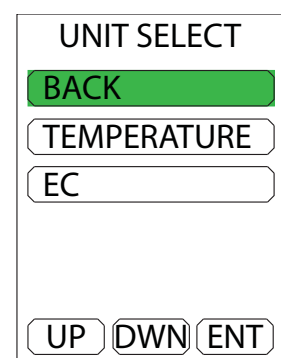
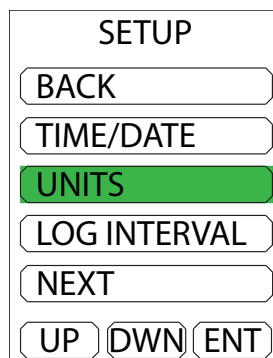

Configure temperature units:

Temperature may be displayed in °F or °C.

Note: Check alarm settings when converting temperature units.

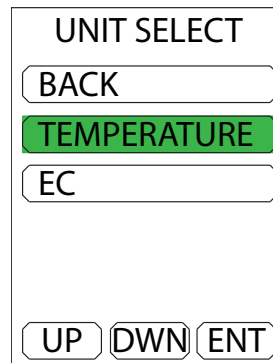

1. Select **TEMPERATURE** from the units menu.

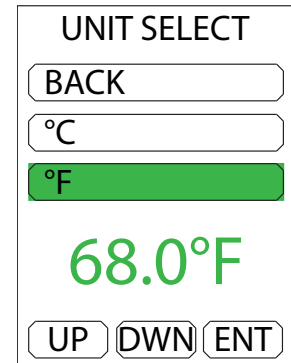

2. Select the desired units and press **ENT**.

Logging Interval



Adjust the interval for recording data points in the on-board memory. Acceptable values are from 1 - 65535 seconds.

21,600 data points can be stored for each sensor value. The most recent 120 data points are shown on the graphical history.

The entire data history may be downloaded from the sensor to a .csv file with the LX1 USB AgrowLINK and free software.

Note: 60 second intervals = 15 days of data storage.

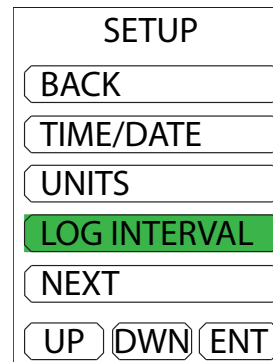

1. Select **LOG INTERVAL** from the setup menu.

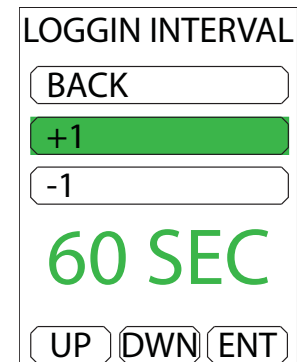

2. Adjust the value then select **BACK**.

COMM Mode



COMM mode specifies whether the sensor is a normal passive device or "mini-master" device.

NORMAL Use with GrowControl master controller systems or stand-alone and data logging applications.

MINI-MASTER Use with MCX mini-climate control system. (GrowNET cross-over adapter required.)

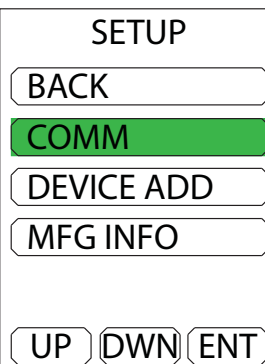

1. Select **COMM** from the setup menu.

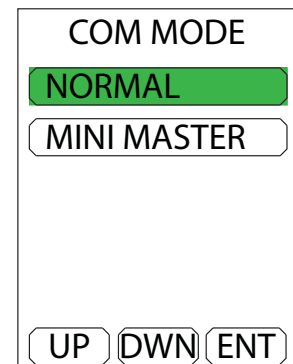

2. Select a mode and press **ENT**.

Device Address

MNU ► SETUP ► NEXT ► DEVICE ADD

Sensors are digitally addressable from 1-249 and will be assigned an address automatically by Agrowtek's control systems, or can be configured manually for MODBUS applications via the menu.

NOTE: All of Agrowtek's devices use address 254 as a broadcast address.



NOTE: Address must be set to 0 for Relay control. The "RELAY" menu item will not appear unless the device address is set to 0.

SETUP		
BACK		
COMM		
DEVICE ADD		
MFG INFO		
BACKLIGHT		
UP	DWN	ENT

1. Select **DEVICE ADD** from the setup menu.

DEVICE ADDRESS		
BACK		
+1		
-1		
0 Addr		
UP	DWN	ENT

2. Adjust the value then select **BACK**.

Manufacturing Info

MNU ► SETUP ► NEXT ► MFG INFO

Manufacturer information such as serial number, date of manufacture, hardware and firmware versions can be read from the MFG INFO page.

SETUP		
BACK		
COMM		
DEVICE ADD		
MFG INFO		
BACKLIGHT		
UP	DWN	ENT

SERIAL NUMBER: 17090554		
DATE OF MFG: 09/15/17		
HW VERSION: C		
FW VERSION: 02.03.84		
EXIT		

Display Back Light Timer

MNU ► SETUP ► NEXT ► BACKLIGHT

The display back light can be programmed to turn off after a specified time of inactivity from the last time a button is pressed.

The delay can be set from 1-255 minutes, or set to 0 to disable the back light timer and keep the display on continuously.

SETUP		
BACK		
COMM		
DEVICE ADD		
MFG INFO		
BACKLIGHT		
UP	DWN	ENT

BACKLIGHT		
BACK		
+1		
-1		
60 Min		
UP	DWN	ENT

Connection to GrowControl™ GCX

All GrowNET™ devices are connected using standard CAT5 Ethernet cable with RJ-45 connections.

Devices can be connected directly to the GrowNET™ ports on the bottom of the controller, or through HX8 GrowNET™ hubs. It is typical to simplify cabling by locating hubs centrally in hall ways and rooms allowing single runs from an 8-port device hub back to a central hub or back to the controller.

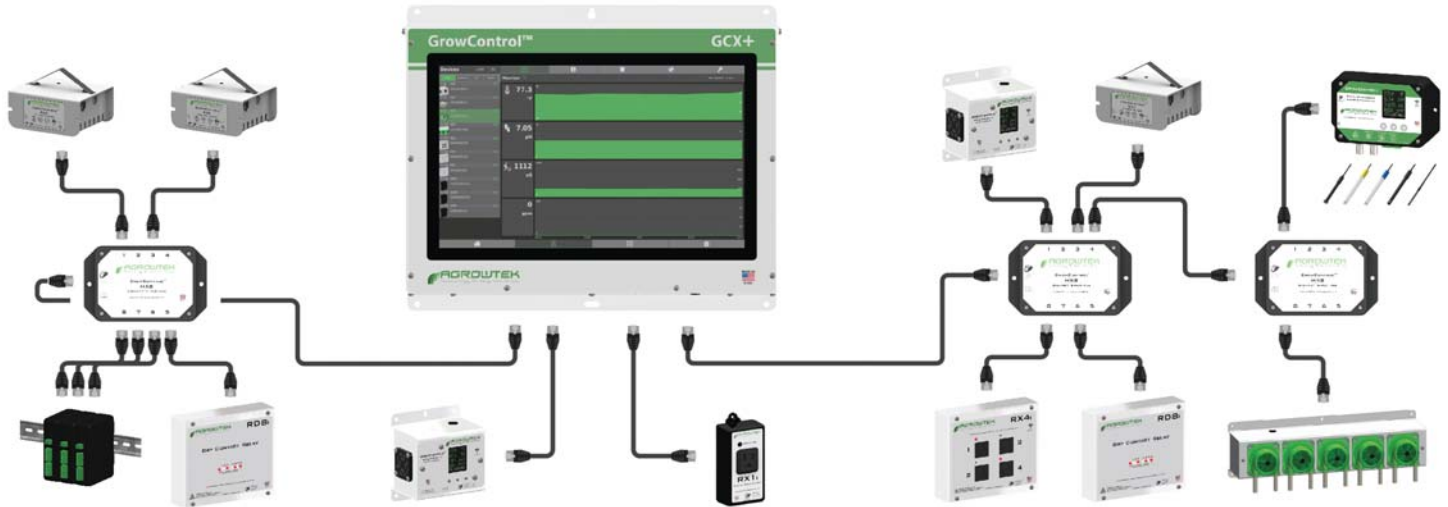

Refer to the GCX controller manual for details on adding the device to the system.

GrowNET™ Hubs

HX8 GrowNET™ hubs expand a single port into eight more ports. Hubs can be daisy-chained to form a network of up to 100 devices per GrowNET™ bus. Individually buffered port transceivers provide excellent signal integrity and extended communication strength and range.

Hubs provide up to 1A of power for operating sensors and most relays directly over the CAT5 cable. A DC jack on the hub provides 24Vdc power to the ports from the included wall power supply. A terminal block power option is also available.



Installation Notes

⚠ NOTICE

GrowNET™ ports use standard RJ-45 connections but are NOT compatible the Ethernet network equipment. *Do not connect GrowNET™ ports to Ethernet ports or network switch gear.*

⚠ DIELECTRIC GREASE

Dielectric grease is recommended on RJ-45 GrowNET™ connections when used in humid environments. Place a small amount of grease onto the RJ-45 plug contacts before inserting into the GrowNET™ port. *Non-conductive grease is designed to prevent corrosion from moisture in electrical connectors.*

- Loctite LB 8423
- Dupont Molykote 4/5
- CRC 05105 Di-Electric Grease
- Super Lube 91016 Silicone Dielectric Grease
- Other Silicone or Lithium based insulating grease

Connection to RX4i Intelligent Relay

A direct-link connection between a SXE sensor and RX4i relay requires Agrowtek's cross-over adapter.

⚠ IMPORTANT! ONLY use cross-over adapters provided by Agrowtek. Do not use other cross-over adapters or cross-over cables unless they are constructed exactly as diagramed on the cross-over diagram. Incorrect cross-over adapters or cables can cause damage to the equipment.



Create a "mini" control system by linking a sensor directly to a relay with a cross-over (red) cable. Sensor will automatically connect and communicate with the relay on power-up. Relays do not provide power over the Ethernet cable, so a power supply is required with the sensor. An internal battery backup maintains the time during a power outage for un-interrupted operation.

Control relays individually based on:

- Temperature (heat or cool)
- Humidity (humidify or dehumidify)
- CO2 (add or exhaust)
- Repeat Cycle Timer (1 - 65535 seconds)
- 24-Hour Timer
- Light sensor for day & night set-points

Cross-Over Cable

A custom cross-over cable can be constructed as an *alternative* to using the cross-over adapter and two standard, straight Ethernet cables as shown in the diagram above. **The cross-over wiring MUST match the diagram below.**

Pins 7 & 8 carry 24Vdc power and must be straight through or damage may result to the equipment.

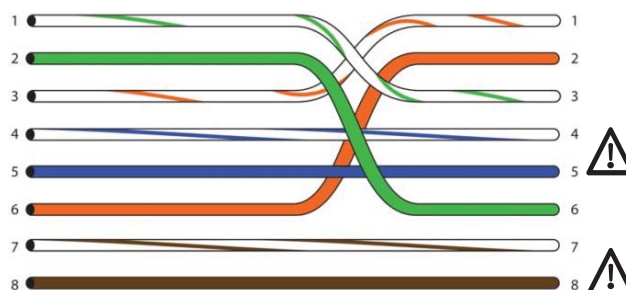

Connection to USB AgrowLINK

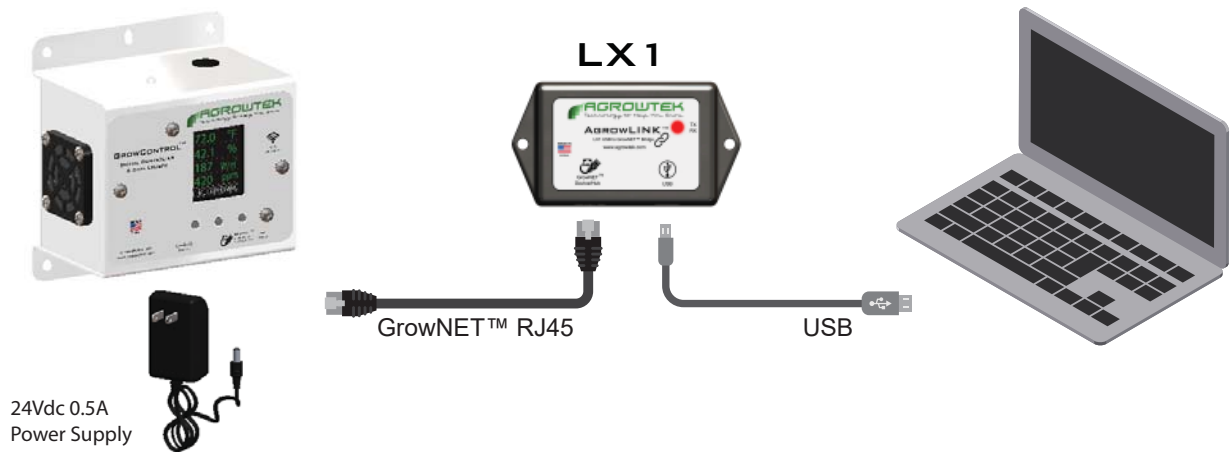

LX1 USB AgrowLINK connects Agrowtek's devices to a computer's USB port for:

- Firmware Updates
- Calibration
- Configuration
- Data Logging Download
- More

Visit www.agrowtek.com for free software applications.

Standard FTDI drivers automatically install in Windows. GrowNET protocol available for custom software applications; sample C# code available. See software manual for more information.

Connection to 4-20mA Outputs

Option 1: Use the LX3 Analog Bridge with Mini-Din 6 analog sensor port connection and removable terminal block for wire connections. Terminal block includes 24V power terminals and four terminals for the analog channels. 4-20mA linear outputs correspond to the ranges in the specifications table.

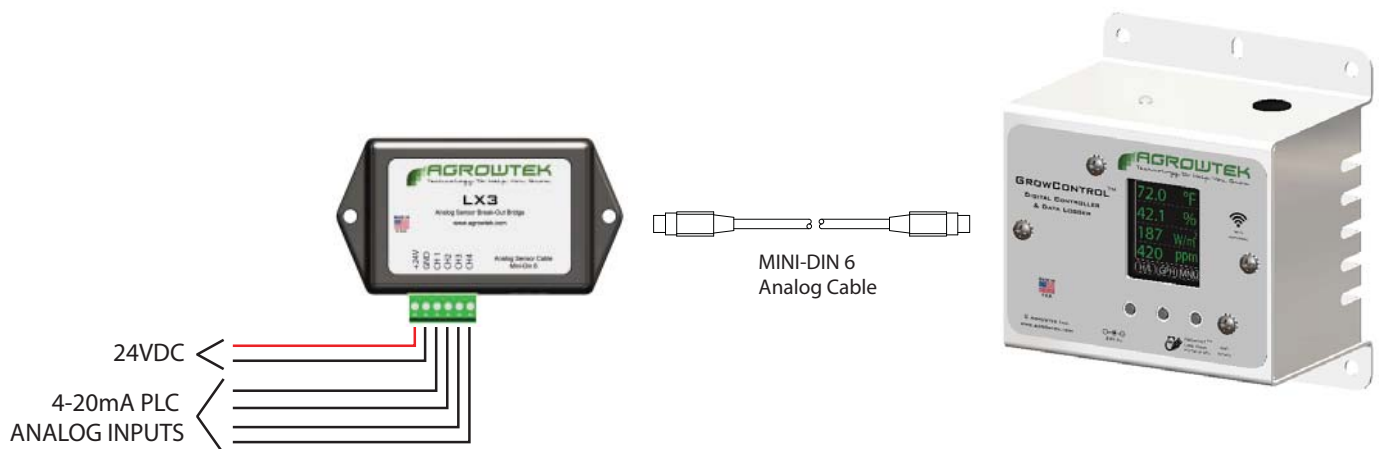

Connection to MODBUS RTU

RS-485

Use the LX2 ModLINK to connect MODBUS devices to the GrowNET™ port.



3.3/5Vdc Serial Bus Compatible.
Include required bus terminating resistors per EIA standard.

Serial Speed & Format

The default serial data format for the LX2 ModLINK interface is: **19,200 baud, 8-N-1.**

Alternate speeds and formats between 9,600 - 115,200 baud may be configured with the free AgrowLINK PC utility using a LX1 USB AgrowLINK and the cross-over adapter supplied with the LX2 ModLINK.

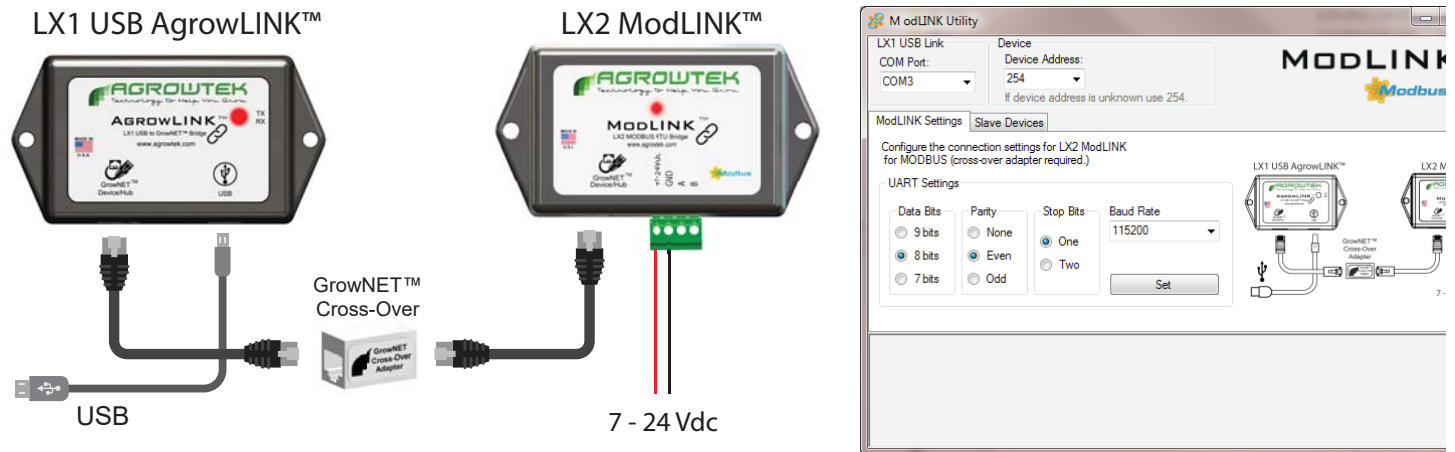

See MODBUS manual for more information.

 [MODBUS Manual](#)

Supported Commands

0x03 Read Multiple Registers
0x06 Write Single Register

A request to use a function that is not available will return an illegal function exception.

Register Types

All registers are 16 bits wide with addresses using the standard MODICON protocol. Floating point values use the standard IEEE 32-bit format occupying two contiguous 16 bit registers. ASCII values are stored with two characters (bytes) per register in hexadecimal format.

Sensor Value Registers

Sensor values are available in integer or floating point formats depending on the register requested (see map.)

Sensor #	Type	Integer Scale	Range
1	Temperature	x100	-2000 - 6000 (-20 - 60°C) / -400 - 14000 (-4 - 140°F)
2	Humidity	x10	0 - 1000 (0 - 100%)
3	Light	x1	0 - 1000 W/m ²
4	CO ₂	x1	0 - 10,000 ppm

For example: an integer temperature value of 2417 is equal to a temperature reading of 24.17°C.

The value "9999" is representative of a failed sensor (with the exception of CO₂ which will read 0.)

Toggle Units Register

Sensors with alternate units may toggle the units using the "toggle units" register. To toggle the units, send the sensor channel number to the toggle register. *This register is write-only.*

For example: to toggle between °F and °C, send a "1" to register 1002.

Calibration Registers

Calibration registers are 16-bit signed integers for the purpose of calibrating the sensor values or analog output channels. Calibration may be achieved by writing the desired calibrated value to the associated register. Writing to the calibration registers automatically invokes the calibration routine for that register.

Offset Calibration

Offset, or zero calibration, is an arithmetic positive or negative correction to the sensor reading and is the only type of sensor calibration available on climate/environmental sensors.

To perform a sensor offset calibration, simply write the corrected sensor value to the offset calibration register (taking into account the integer scale as shown above.)

For example: to set the temperature to a calibrated value of 25°C, write the value "2500."

Analog Calibration

Analog output calibration sends a positive or negative offset to the respective output channel's digital to analog converter (DAC.) The DAC has a resolution of 0.005mA/bit.

±1 calibration bit = ±0.005mA adjustment

For example: to shift the analog output up by 0.1mA, set the analog offset value to +20. (0.1 / 0.005 = 20)

MODBUS Holding Registers

Parameter	Description	Range	Type	Access	Address
Address	Device Slave Address	1 - 247	8 bit	R/W	40001
Serial#	Device Serial Number	ASCII	8 char	R	40004
DOM	Date of Manufacture	ASCII	8 char	R	40008
HW Version	Hardware Version	ASCII	8 char	R	40012
FW Version	Firmware Version	ASCII	8 char	R	40016
Toggle Units	Toggle sensor units	1 - 4	16 bit, unsigned	W	41002
Sensor Reading, Integer	Temperature	-2000 - 6000 (-20 - 60°C)	16 bit, signed	R	40101
	Humidity	0 - 1000 (0 - 100%)			40102
	Light	0 - 1000 W/m2			40103
	CO2	0 - 10,000ppm			40104
Sensor Reading, Float	Temperature	-20.00- 60.00 °C	32 bit, floating pt	R	40201
	Humidity	0 - 100.0 %			40203
	Light	0 - 1000 W/m2			40205
	CO2	0 - 10,000ppm			40207
Calibration Input, Offset (Zero)	Temperature	See integer ranges above.	16 bit, signed	W	41101
	Humidity				41102
	Light				41103
	CO2				41104
Calibration Input, Analog Output	Temperature	-255 - 255 (bits)	16 bit, signed	W	41301
	Humidity				41302
	Light				41303
	CO2				41304

A request to read or write a register that is not available will return an illegal address exception.

Storage and Disposal

Storage

Store equipment in a clean, dry environment with ambient temperature between 10-50°C.

Disposal

This industrial control equipment may contain traces of lead or other metals and environmental contaminants and must not be discarded as unsorted municipal waste, but must be collected separately for the purpose of treatment, recovery and environmentally sound disposal. Wash hands after handling internal components or PCB's.

Warranty

Agrowtek Inc. warrants that all manufactured products are, to the best of its knowledge, free of defective material and workmanship and warrants this product for 1 year from the date of purchase. This warranty is extended to the original purchaser from the date of receipt. This warranty does not cover damages from abuse, accidental breakage, or units that have been modified, altered, or installed in a manner other than that which is specified in the installation instructions. Agrowtek Inc. must be contacted prior to return shipment for a return authorization. No returns will be accepted without a return authorization. This warranty is applicable only to products that have been properly stored, installed, and maintained per the installation and operation manual and used for their intended purpose. This limited warranty does not cover products installed in or operated under unusual conditions or environments including, but not limited to, high humidity or high temperature conditions. The products which have been claimed and comply with the aforementioned restrictions shall be replaced or repaired at the sole discretion of the Agrowtek Inc. at no charge. This warranty is provided in lieu of all other warranty provisions, express or implied. It is including but not limited to any implied warranty of fitness or merchantability for a particular purpose and is limited to the Warranty Period. In no event or circumstance shall Agrowtek Inc. be liable to any third party or the claimant for damages in excess of the price paid for the product, or for any loss of use, inconvenience, commercial loss, loss of time, lost profits or savings or any other incidental, consequential or special damages arising out of the use of, or inability to use, the product. This disclaimer is made to the fullest extent allowed by law or regulation and is specifically made to specify that the liability of Agrowtek Inc. under this limited warranty, or any claimed extension thereof, shall be to replace or repair the Product or refund the price paid for the Product.